

Y strainer in PP-H, PP-H mesh size 0.8 mm, with ANSI* flanges

Popis

* DIN = EN1092-1 PN10 ANSI = ASME B16.5 Class 150 Please contact us for other mesh size

EPDM

#	d (mm)	DN (mm)	DN (inch)	L (mm)	H (mm)	PN (bar)
1	75	65	2"1/2	290	236	10
2	90	80	3"	310	236	7
3	110	100	4"	350	368	6
4	140	125	5"	400	356	5
5	160	150	6"	480	412	3
6	225	200	8"	600	531	3

FPM

#	d (mm)	DN (mm)	DN (inch)	L (mm)	H (mm)	PN (bar)
1	75	65	2"1/2	290	236	10
2	90	80	3"	310	236	7
3	110	100	4"	350	368	6
4	140	125	5"	400	356	5
5	160	150	6"	480	412	3
6	225	200	8"	600	531	3

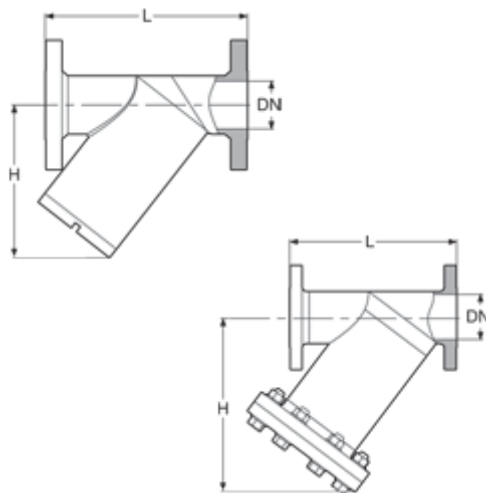

Technické údaje o produktech nejsou závazné. Konstrukční a rozměrové změny vyhrazeny.
Přeloženo z originálu výrobce.

Farprosys, s.r.o.
email: info@farprosys.com
tel. +420 728 757 770
www.atexventilatory.cz